



SL 6-A22

English



# SL 6-A22

Original operating instructions



## 1 Information about the documentation

### 1.1 About this documentation

- Read this documentation before initial operation or use. This is a prerequisite for safe, trouble-free handling and use of the product.
- Observe the safety instructions and warnings in this documentation and on the product.
- Always keep the operating instructions with the product and make sure that the operating instructions are with the product when it is given to other persons.

### 1.2 Explanation of symbols used

#### 1.2.1 Warnings

Warnings alert persons to hazards that occur when handling or using the product. The following signal words are used:

#### **DANGER**

##### **DANGER !**

- ▶ Draws attention to imminent danger that will lead to serious personal injury or fatality.

#### **WARNING**

##### **WARNING !**

- ▶ Draws attention to a potential threat of danger that can lead to serious injury or fatality.





#### **CAUTION**

##### **CAUTION !**

- ▶ Draws attention to a potentially dangerous situation that could lead to slight personal injury or damage to the equipment or other property.

#### 1.2.2 Symbols in the documentation

The following symbols are used in this document:

	Read the operating instructions before use.
	Instructions for use and other useful information
	Dealing with recyclable materials
	Do not dispose of electric equipment and batteries as household waste

#### 1.2.3 Symbols in the illustrations

The following symbols are used in illustrations:

2	These numbers refer to the corresponding illustrations found at the beginning of these operating instructions
3	The numbering reflects the sequence of operations shown in the illustrations and may deviate from the steps described in the text
⑪	Item reference numbers are used in the <b>overview illustrations</b> and refer to the numbers used in the <b>product overview section</b>
	This symbol is intended to draw special attention to certain points when handling the product.

### 1.3 Product-specific symbols

#### 1.3.1 Symbols

The following symbols are used on the product:

	Do not look into the light source.
--	------------------------------------

### 1.4 Product information

products are designed for professional users and only trained, authorized personnel are permitted to operate, service and maintain the products. This personnel must be specifically informed about the possible hazards. The product and its ancillary equipment can present hazards if used incorrectly by untrained personnel or if used not in accordance with the intended use.

The type designation and serial number are printed on the rating plate.

- ▶ Write down the serial number in the table below. You will be required to state the product details when contacting Hilti Service or your local Hilti organization to inquire about the product.

#### Product information

Cordless lamp	SL 6-A22
Generation	01
Serial no.	

### 1.5 Declaration of conformity

We declare, on our sole responsibility, that the product described here complies with the applicable directives and standards. A copy of the declaration of conformity can be found at the end of this documentation.

The technical documentation is filed here:

**Hilti** Entwicklungsgesellschaft mbH | Tool Certification | Hiltistrasse 6 | 86916 Kaufering, Germany

## 2 Safety

### 2.1 Use and care

- ▶ Use the product only when it is in perfect working order.
- ▶ Never tamper with or modify the product in any way.
- ▶ Keep the product out of reach of children.
- ▶ Do not use the product where there is a risk of fire or explosion.
- ▶ Use the product in a dry environment only.
- ▶ Replace the complete cordless lamp when the light source has reached the end of its life. The light source in this cordless lamp is not replaceable.
- ▶ Do not look into the beam and do not direct the beam toward other persons.
- ▶ Whenever you suspend the product by means of the scaffold hook, make sure that it is securely and safely positioned.

### 2.2 Personal safety

The user and the persons in the vicinity must wear suitable protective goggles, protective gloves and a hard hat while the product is in use!

### 2.3 Battery use and care

- ▶ Observe the special regulations and instructions applicable to the transport, storage and use of Li-ion batteries.
- ▶ Do not expose batteries to high temperatures, direct sunlight or fire.
- ▶ Do not disassemble, crush or incinerate batteries and do not subject them to temperatures over 80 °C.
- ▶ Do not use or charge batteries that have suffered mechanical impact, have been dropped from a height or show signs of damage. In this case, always contact your **Hilti Service**.
- ▶ If the battery is too hot to touch it may be defective. In this case, place the product in a non-flammable location, well away from flammable materials, where it can be kept under observation and allowed to cool down. In this case, always contact your **Hilti Service**.

## 3 Description

### 3.1 Product overview

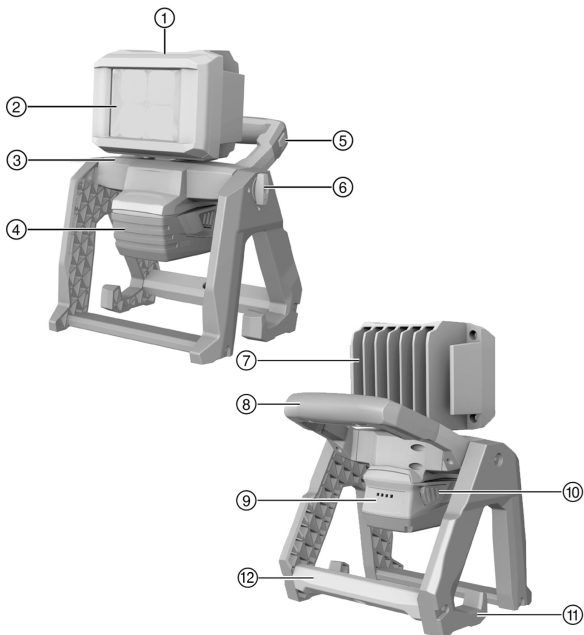

- |                                       |                                     |
|---------------------------------------|-------------------------------------|
| ① Lamp head                           | ⑦ Heat sink                         |
| ② LEDs                                | ⑧ Carrying handle                   |
| ③ Vertical pivot joint                | ⑨ Battery state of charge indicator |
| ④ Battery                             | ⑩ Battery release button            |
| ⑤ Switch for mode change (brightness) | ⑪ Suspension/attachment hook        |
| ⑥ Locking switch, vertical            | ⑫ 5/8" thread for tripod mount      |

### 3.2 Intended use

The product described is a cordless floodlight. It is for lighting up jobsites. The lamp head can be pivoted horizontally and vertically. Additionally, the light can be set on a flat surface, suspended from various construction



materials by means of the integral hook, or mounted on a tripod with 5/8" thread.

- ▶ Use only **Hilti** Li-ion batteries of the B 22 series with this product.
- ▶ Use only the **Hilti** battery chargers of the C4/36 series to charge these batteries.

### 3.3 Charge state indicator

Lightly press (no more than until resistance is perceptible) either of the battery release buttons to check the charge state of the Li-ion battery.

Status	Meaning
4 LEDs light up.	Charge state: 75 % to 100 %
3 LEDs light up.	Charge state: 50 % to 75 %
2 LEDs light up.	Charge state: 25 % to 50 %
1 LED lights up.	Charge state: 10 % to 25 %
1 LED flashes.	Charge state: < 10 %

 If the LEDs of the charge state indicator flash, follow the instructions in the 'Troubleshooting' section.

### 3.4 Items supplied

Cordless lamp, operating instructions.

Other system products approved for use with this product can be found at your local **Hilti Store** or online at: [www.hilti.group](http://www.hilti.group) | USA: [www.hilti.com](http://www.hilti.com)

### 3.5 4-mode switch

Use the 4-mode switch to set brightness.

Status	Meaning
Press once	The lamp shines at maximum brightness (100 %).
Press twice	The lamp shines at reduced brightness (66 %).
Press three times	The lamp shines at reduced brightness (33 %).
Press and hold down for several seconds	The lamp is off.

 The brightness setting last selected is used again the next time the lamp is switched on.

## 4 Technical data

	SL 6-A22
Voltage	21.6 V
Brightness	3,000 lm
Weight	3.2 kg

### 4.1 Battery

Battery operating voltage	21.6 V
Ambient temperature for operation	-17 °C ... 60 °C
Storage temperature	-20 °C ... 40 °C
Battery charging starting temperature	-10 °C ... 45 °C

## 5 Operation

### 5.1 Preparations at the workplace

#### CAUTION

##### **Risk of injury by inadvertent starting!**

- ▶ Before inserting the battery, make sure that the product is switched off.
- ▶ Remove the battery before making any adjustments to the power tool or before changing accessories.

Observe the safety instructions and warnings in this documentation and on the product.

#### 5.1.1 Inserting the battery

#### CAUTION

##### **Risk of injury by short circuit or falling battery!**

- ▶ Before inserting the battery, make sure that the contacts on the battery and the contacts on the product are free of foreign matter.
- ▶ Make sure that the battery always engages correctly.

1. Charge the battery fully before using it for the first time.
2. Push the battery into the battery holder until it engages with an audible click.
3. Check that the battery is seated securely.

#### 5.1.2 Removing the battery

1. Press the release buttons on the battery.
2. Pull the battery out of its holder in the device.

#### 5.1.3 Charging the battery

1. Before charging the battery, read the operating instructions for the charger.

2. Make sure that the contacts on the battery and the contacts on the charger are clean and dry.
3. Use an approved charger to charge the battery.

#### 5.1.4 Switching on

**i** Whenever you engage the product on the universal hook or mount it on a tripod, make sure that the product is secure.

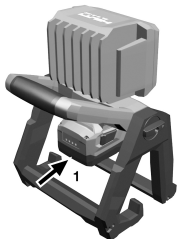

- ▶ Select a mode by pressing the 4-mode switch.

#### 5.1.5 Turning the lamp head

##### **⚠ CAUTION**

**Risk of damage to the eyes (the retina).** Looking directly into the lamp presents a risk of damage to the eyes (the retina).

- ▶ Do not direct the lamp at yourself or at anyone else.
- ▶ Do not, under any circumstances, look into the lamp.

##### **⚠ CAUTION**

**There is a risk of crushing fingers in the joint area** When the lamp head is being turned, there is a risk of the fingers being caught between the support leg and the casing.

- ▶ Wear protective gloves.

**i** The multi-position hinge and the lamp head can be turned in either direction along the axis. Do not attempt to force the lamp head past the end stops.

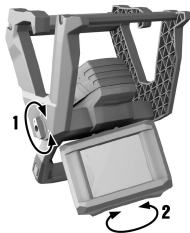

1. Unlock the multi-position hinge with the locking switch to adjust the lamp vertically.
2. Then turn the multi-position hinge in the desired direction.
3. Lock the multi-position hinge with the locking switch.
4. Turn the lamp head to the desired position to adjust the lamp horizontally.

## 6 Care and maintenance

### **WARNING**

#### **Risk of injury with battery inserted !**

- ▶ Always remove the battery before carrying out care and maintenance tasks!

#### **Care and maintenance of the tool**

- Carefully remove stubborn dirt.
- Clean the air vents carefully with a dry brush.
- Use only a slightly damp cloth to clean the casing. Do not use cleaning agents containing silicone as these can attack the plastic parts.

#### **Care of the Li-ion batteries**

- Keep the battery free from oil and grease.
- Use only a slightly damp cloth to clean the casing. Do not use cleaning agents containing silicone as these may attack the plastic parts.
- Avoid ingress of moisture.

#### **Maintenance**

- Check all visible parts and controls for signs of damage at regular intervals and make sure that they all function correctly.
- Do not operate the product if signs of damage are found or if parts malfunction. Have it repaired immediately by **Hilti Service**.
- After cleaning and maintenance, fit all guards or protective devices and check that they function correctly.

- i** To help ensure safe and reliable operation, use only genuine Hilti spare parts and consumables. Spare parts, consumables and accessories approved by Hilti for use with the product can be found at your local **Hilti Store** or online at: [www.hilti.group](http://www.hilti.group).

## 6.1 Light source

- i** The light source in this lamp is not replaceable!  
When the light source reaches the end of its service life, the entire lamp has to be replaced.

## 7 Transport and storage of cordless tools

### Transport

#### **⚠ CAUTION**

#### **Accidental starting during transport !**

- ▶ Always transport your products with the batteries removed!
- ▶ Remove the battery.
- ▶ Never transport batteries in bulk form (loose, unprotected).
- ▶ Check the tool and batteries for damage before use after long periods of transport.

### Storage

#### **⚠ CAUTION**

#### **Accidental damage caused by defective or leaking batteries !**

- ▶ Always store your products with the batteries removed!
- ▶ Store the tool and batteries in a place that is as cool and dry as possible.
- ▶ Never store batteries in direct sunlight, on heating units or behind a window pane.
- ▶ Store the tool and batteries in a place where they cannot be accessed by children or unauthorized persons.
- ▶ Check the tool and batteries for damage before use after long periods of storage.

## 8 Troubleshooting

If the trouble you are experiencing is not listed in this table or you are unable to remedy the problem by yourself, please contact **Hilti Service**.

### 8.1 Troubleshooting

If the trouble you are experiencing is not listed in this table or you are unable to remedy the problem by yourself, contact **Hilti Service**.

Trouble or fault	Possible cause	Action to be taken
The battery does not engage with an audible double click.	The retaining lugs on the battery are dirty.	▶ Clean the retaining lugs and push the battery in until it engages.
1 LED flashes. The device does not work.	The battery is discharged.	▶ Change the battery and charge the empty battery.
	The battery is too hot or too cold.	▶ Allow the battery to cool down or warm up slowly to room temperature.

## 9 Disposal

Most of the materials from which **Hilti** tools and appliances are manufactured can be recycled. The materials must be correctly separated before they can be recycled. In many countries, your old tools, machines or appliances can be returned to **Hilti** for recycling. Ask **Hilti Service** or your Hilti representative for further information.

### Battery disposal

Improper disposal of batteries can result in health hazards from leaking gases or fluids.

- ▶ DO NOT send batteries through the mail!
- ▶ Cover the terminals with a non-conductive material (such as electrical tape) to prevent short circuiting.
- ▶ Dispose of your battery out of the reach of children.
- ▶ Dispose of the battery at your **Hilti Store**, or consult your local governmental garbage disposal or public health and safety resources for disposal instructions.



- ▶ Do not dispose of power tools, electronic equipment or batteries as household waste!

## 10 RoHS (Restriction of Hazardous Substances)

Click on the link to go to the table of hazardous substances: [qr.hilti.com/r9356561](http://qr.hilti.com/r9356561).

There is a link to the RoHS table, in the form of a QR code, at the end of this document.

## 11 Manufacturer's warranty

- ▶ Please contact your local **Hilti** representative if you have questions about the warranty conditions.



**Hilti Aktiengesellschaft**  
Feldkircherstraße 100  
9494 Schaan | Liechtenstein

**SL 6-A22 (01)**

[2017]

2014/30/EU

EN ISO 12100

2011/65/EU

EN 60598-1

EN 60598-2-8

EN 62471

EN 62493

Schaan, 03/2019

**Paolo Luccini**

Head of BA Quality and  
Process-Management

BA Electric Tools & Accessories

**Tassilo Deinzer**

Executive Vice President

Business Unit Power Tool &  
Accessories



SL 6-A22



Hilti Corporation  
LI-9494 Schaan  
Tel.:+423 234 21 11  
Fax:+423 234 29 65  
[www.hilti.group](http://www.hilti.group)



2164701



Hilti Connect